

# Spannzangen

## Collets



### ■ Inhalt:

- | DIN 6388B / OZ (doppelt geschlitzt)
- | DIN 6388A / OZ (einfach geschlitzt)
- | DIN 6499 / ER / ESX (ER 8 - ER 50)
- | DIN 6499 / ER / ESX, Präzisionsausführung (ER 8 - ER 40)
- | DIN 6499 / ER / ESX, abgedichtet (ER 11 - ER 40)
- | Gewindebohrzangen mit Innenvierkant (ER 16 - ER 50)
- | Gewindebohrzangen mit Längenausgleich
- | [Spannzangen Erickson, Typ DK](#)
- | Typ 385 E (5C), Typ 386 E, Typ 369 E (R8)
- | Direktspannzangen
- | DIN 6343 (161 E, 163 E, 173 E, 185 E, 193 E)
- | [Spannköpfe](#)
- | Spannzangensätze
- | Anschlagschrauben
- | Aluminiumkoffer

### ■ Content:

- | *DIN 6388B / OZ (double slotted)*
- | *DIN 6388A / OZ (single slotted)*
- | *DIN 6499 / ER / ESX (ER 8 - ER 50)*
- | *DIN 6499 / ER / ESX, precision design (ER 8 - ER 40)*
- | *DIN 6499 / ER / ESX, sealed (ER 11 - ER 40)*
- | *Tapping collets with internal square (ER 16 - ER 50)*
- | *Tapping collets with length compensation*
- | [Collet Erickson, Type DK](#)
- | *Type 385 E (5C), type 386 E, type 369 E (R8)*
- | *Taper collets*
- | *DIN 6343 (161 E, 163 E, 173 E, 185 E, 193 E)*
- | [Clamping heads](#)
- | [Collet sets](#)
- | [Stop screws](#)
- | [Aluminium cases](#)

## Spannzangen OZ, DIN 6388B, doppelt geschlitzt Collets OZ, DIN 6388B, double slotted

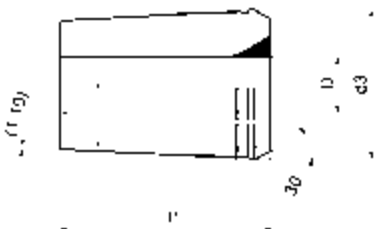

### Typ 415 E (OZ 16), 0,5 mm steigend / stepped

D mm	OZ	d3 mm	l1 mm	Art.-Nr. / Order no.	EUR
2-16	OZ 16	25,5	40	06-415E-Ø	6,10

### Typ 4541 E (OZ 20), 1 mm steigend / stepped

D mm	OZ	d3 mm	l1 mm	Art.-Nr. / Order no.	EUR
4-20	OZ 20	29,8	45	06-4541E-Ø	11,60

### Typ 462 E (OZ 25), 0,5 mm steigend / stepped

D mm	OZ	d3 mm	l1 mm	Art.-Nr. / Order no.	EUR
2-25	OZ 25	35,5	52	06-462E-Ø	6,60

### Typ 467 E (OZ 32), 0,5 mm steigend / stepped

D mm	OZ	d3 mm	l1 mm	Art.-Nr. / Order no.	EUR
3-32	OZ 32	43,7	60	06-467E-Ø	9,20

### Typ 468 E (OZ 40), 1 mm steigend / stepped

D mm	OZ	d3 mm	l1 mm	Art.-Nr. / Order no.	EUR
12-40	OZ 40	52,2	68	06-468E-Ø	34,20

## Spannzangen OZ, DIN 6388A, einfach geschlitzt Collets OZ, DIN 6388A, single slotted



### Typ 401 E (OZ 8), 0,5 mm steigend / stepped

D mm	OZ	d3 mm	l1 mm	Art.-Nr. / Order no.	EUR
1,0-2,5	OZ 8	14,5	26	06-401E-Ø	10,30
3,0-8,0	OZ 8	14,5	26	06-401E-Ø	9,90

### Typ 410 E (OZ 16), 1 mm steigend / stepped

D mm	OZ	d3 mm	l1 mm	Art.-Nr. / Order no.	EUR
2-16	OZ 16	25,5	40	06-410E-Ø	6,90

### Typ 444 E (OZ 25), 1 mm steigend / stepped

D mm	OZ	d3 mm	l1 mm	Art.-Nr. / Order no.	EUR
2-25	OZ 25	35,5	52	06-444E-Ø	7,60

### Typ 450 E (OZ 32), 1 mm steigend / stepped

D mm	OZ	d3 mm	l1 mm	Art.-Nr. / Order no.	EUR
4-32	OZ 32	44	60	06-450E-Ø	10,20

- Lagerstandard / in stock
- ▶ innerhalb weniger Tage / within a few days
- auf Anfrage / on request
- \* auslaufende Größe / as stock lasts

# Spannzangen ER/ESX, DIN 6499

## Collets ER/ESX, DIN 6499

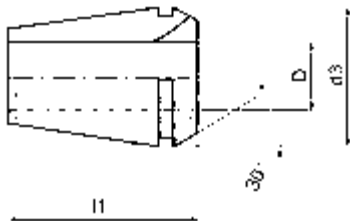

### ER 8 (4004 E), 0,5 mm steigend / stepped

D mm	d3 mm	l1 mm	Art.-Nr. / Order no.	EUR
1-5	8,5	13,5	09-9008-Ø	7,80

### ER 11 (4008 E), 0,5 mm steigend / stepped

D mm	d3 mm	l1 mm	Art.-Nr. / Order no.	EUR
1-7	11,5	18	09-9011-Ø	6,00

### ER 16 (426 E), 0,5 mm steigend / stepped

D mm	d3 mm	l1 mm	Art.-Nr. / Order no.	EUR
1-10	17	27,5	09-9016-Ø	5,60

### ER 20 (428 E), 0,5 mm steigend / stepped

D mm	d3 mm	l1 mm	Art.-Nr. / Order no.	EUR
1-2,5	21	31,5	09-9020-Ø	6,40
3-13	21	31,5	09-9020-Ø	5,90

### ER 25 (430 E), 0,5 mm steigend / stepped

D mm	d3 mm	l1 mm	Art.-Nr. / Order no.	EUR
1-2,5	26	34	09-9025-Ø	6,70
3-16	26	34	09-9025-Ø	6,00

### ER 32 (470 E), 0,5 mm steigend / stepped

D mm	d3 mm	l1 mm	Art.-Nr. / Order no.	EUR
1-2,5	33	40	09-9032-Ø	7,80
3-20	33	40	09-9032-Ø	6,00

### ER 40 (472 E), 1 mm steigend / stepped

D mm	d3 mm	l1 mm	Art.-Nr. / Order no.	EUR
3-26	41	46	09-9040-Ø	7,60
27-30	41	46	09-9040-Ø	17,20

### ER 50 (477 E), 1 mm steigend / stepped

D mm	d3 mm	l1 mm	Art.-Nr. / Order no.	EUR
6-34	52	60	09-9050-Ø	18,80

# Präzisionsausführung, Spannzangen ER/ESX, DIN 6499

## Precision design, collets ER/ESX, DIN 6499

D min. mm	D max. mm	l mm	Rundlauf / Runout
1	1,6	6	0,005
1,6	3	10	0,008
3	7	16	0,008
7	10	25	0,008
10	18	40	0,010
18	26	50	0,010

### ER 8 (4004 E) - Präzision / precision, 0,5 mm steigend / stepped

D mm	d3 mm	l1 mm	Art.-Nr. / Order no.	EUR
1-2,5	8,5	13,5	● 09-9008-0UP	9,00
3-5	8,5	13,5	● 09-9008-0UP	8,30

### ER 11 (4008 E) - Präzision / precision, 0,5 mm steigend / stepped

D mm	d3 mm	l1 mm	Art.-Nr. / Order no.	EUR
1-2,5	11,5	18	● 09-9011-0UP	9,00
3-7	11,5	18	● 09-9011-0UP	8,30

### ER 16 (426 E) - Präzision / precision, 0,5 mm steigend / stepped

D mm	d3 mm	l1 mm	Art.-Nr. / Order no.	EUR
1-2,5	17	27,5	● 09-9016-0UP	9,30
3-10	17	27,5	● 09-9016-0UP	8,50

### ER 20 (428 E) - Präzision / precision, 1 mm steigend / stepped

D mm	d3 mm	l1 mm	Art.-Nr. / Order no.	EUR
1-2	21	31,5	● 09-9020-0UP	10,70
3-13	21	31,5	● 09-9020-0UP	9,50

### ER 25 (430 E) - Präzision / precision, 1 mm steigend / stepped

D mm	d3 mm	l1 mm	Art.-Nr. / Order no.	EUR
1-2	26	34	● 09-9025-0UP	9,50
3-16	26	34	● 09-9025-0UP	9,20

### ER 32 (470 E) - Präzision / precision, 1 mm steigend / stepped

D mm	d3 mm	l1 mm	Art.-Nr. / Order no.	EUR
2	33	40	● 09-9032-2.0UP	12,70
3-20	33	40	● 09-9032-0UP	10,40

### ER 40 (472 E) - Präzision / precision, 1 mm steigend / stepped

D mm	d3 mm	l1 mm	Art.-Nr. / Order no.	EUR
3-26	41	46	● 09-9040-0UP	12,90

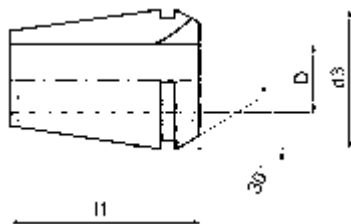

**PRÄZISION /  
PRECISION**

Spannzangen abgedichtet ER/ESX, DIN 6499, 1 mm steigend  
 Sealed collets ER/ESX, DIN 6499, 1 mm stepped

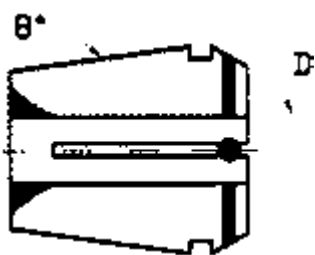

**ABGEDICHTET /  
 SEALED**

**ER 11 (4012 E) - abgedichtet / sealed**

D mm	Art.-Nr. / Order no.	EUR
3 - 7 mm	<a href="#">09-9011-ØS</a>	15,70

**ER 16 (425 E) - abgedichtet / sealed**

D mm	Art.-Nr. / Order no.	EUR
3 - 10 mm	<a href="#">09-9016-ØS</a>	15,70

**ER 20 (427 E) - abgedichtet / sealed**

D mm	Art.-Nr. / Order no.	EUR
3 - 13 mm	<a href="#">09-9020-ØS</a>	16,90

**ER 25 (429 E) - abgedichtet / sealed**

D mm	Art.-Nr. / Order no.	EUR
3 - 16 mm	<a href="#">09-9025-ØS</a>	17,20

**ER 32 (469 E) - abgedichtet / sealed**

D mm	Art.-Nr. / Order no.	EUR
3 - 20 mm	<a href="#">09-9032-ØS</a>	17,50

**ER 40 (471 E) - abgedichtet / sealed**

D mm	Art.-Nr. / Order no.	EUR
4 - 26 mm	<a href="#">09-9040-ØS</a>	20,40

# Gewindebohrzangen mit Innenvierkant

## Tapping collets with internal square

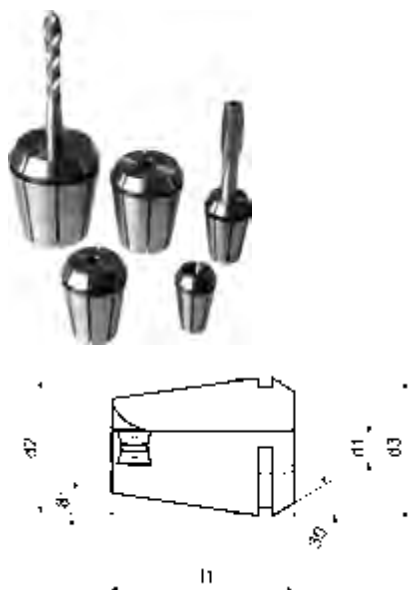

### ER 16-GB mit Innenvierkant

#### ER 16-GB with internal square

d1 x □ mm	d2 mm	d3 mm	l1 mm	Art.-Nr. / Order no.	EUR
3,5 x 2,7	16	16,8	27,5	● 09-8016-3,5	15,60
4 x 3	16	16,8	27,5	● 09-8016-4,0	15,60
4,5 x 3,4	16	16,8	27,5	● 09-8016-4,5	15,60
5 x 5	16	16,8	27,5	● 09-8016-5,0	15,60
5,5 x 4,3	16	16,8	27,5	● 09-8016-5,5	15,60
6 x 4,9	16	16,8	27,5	● 09-8016-6,0	15,60
7 x 5,5	16	16,8	27,5	● 09-8016-7,0	15,60
8 x 6,2	16	16,8	27,5	● 09-8016-8,0	15,60
9 x 7	16	16,8	27,5	● 09-8016-9,0	15,60

### ER 20-GB mit Innenvierkant

#### ER 20-GB with internal square

d1 x □ mm	d2 mm	d3 mm	l1 mm	Art.-Nr. / Order no.	EUR
3,5 x 2,7	20	20,8	31,5	● 09-8020-3,5	16,90
4 x 3	20	20,8	31,5	● 09-8020-4,0	16,90
4,5 x 3,4	20	20,8	31,5	● 09-8020-4,5	16,90
5 x 5	20	20,8	31,5	● 09-8020-5,0	16,90
5,5 x 4,3	20	20,8	31,5	● 09-8020-5,5	16,90
6 x 4,9	20	20,8	31,5	● 09-8020-6,0	16,90
7 x 5,5	20	20,8	31,5	● 09-8020-7,0	16,90
8 x 6,2	20	20,8	31,5	● 09-8020-8,0	16,90
9 x 7	20	20,8	31,5	● 09-8020-9,0	16,90
10 x 8	20	20,8	31,5	● 09-8020-10,0	16,90
11 x 9	20	20,8	31,5	● 09-8020-11,0	16,90
12 x 9	20	20,8	31,5	● 09-8020-12,0	16,90

### ER 25-GB mit Innenvierkant

#### ER 25-GB with internal square

d1 x □ mm	d2 mm	d3 mm	l1 mm	Art.-Nr. / Order no.	EUR
3,5 x 2,7	25	25,8	34	● 09-8025-3,5	17,20
4 x 3	25	25,8	34	● 09-8025-4,0	17,20
4,5 x 3,4	25	25,8	34	● 09-8025-4,5	17,20
5 x 5	25	25,8	34	● 09-8025-5,0	17,20
5,5 x 4,3	25	25,8	34	● 09-8025-5,5	17,20
6 x 4,9	25	25,8	34	● 09-8025-6,0	17,20
7 x 5,5	25	25,8	34	● 09-8025-7,0	17,20
8 x 6,2	25	25,8	34	● 09-8025-8,0	17,20
9 x 7	25	25,8	34	● 09-8025-9,0	17,20
10 x 8	25	25,8	34	● 09-8025-10,0	17,20
11 x 9	25	25,8	34	● 09-8025-11,0	17,20
12 x 9	25	25,8	34	● 09-8025-12,0	17,20
14 x 11	25	25,8	34	● 09-8025-14,0	17,20
16 x 12	25	25,8	34	● 09-8025-16,0	17,20

Abgedichtete Gewindebohrzangen auf Anfrage lieferbar  
Sealed tapping collets available upon request

- Lagerstandard / in stock
- ▶ innerhalb weniger Tage / within a few days
- auf Anfrage / on request
- ✖ auslaufende Größe / as stock lasts

# Gewindebohrzangen mit Innenvierkant

## Tapping collets with internal square

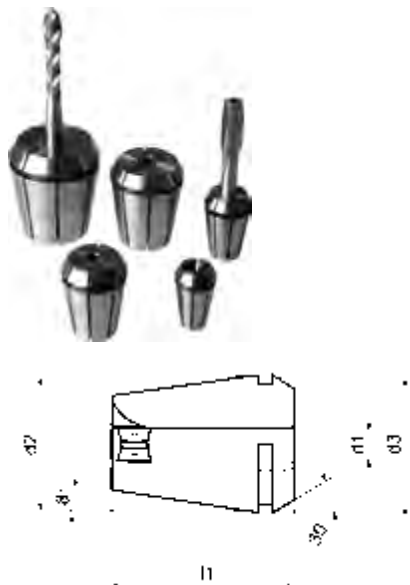

### ER 32-GB mit Innenvierkant

#### ER 32-GB with internal square

d1 x □ mm	d2 mm	d3 mm	l1 mm	Art.-Nr. / Order no.	EUR
3,5 x 2,7	32	32,8	40	● 09-8032-3,5	17,50
4 x 3	32	32,8	40	● 09-8032-4,0	17,50
4,5 x 3,4	32	32,8	40	● 09-8032-4,5	17,50
5 x 5	32	32,8	40	● 09-8032-5,0	17,50
5,5 x 4,3	32	32,8	40	● 09-8032-5,5	17,50
6 x 4,9	32	32,8	40	● 09-8032-6,0	17,50
7 x 5,5	32	32,8	40	● 09-8032-7,0	17,50
8 x 6,2	32	32,8	40	● 09-8032-8,0	17,50
9 x 7	32	32,8	40	● 09-8032-9,0	17,50
10 x 8	32	32,8	40	● 09-8032-10,0	17,50
11 x 9	32	32,8	40	● 09-8032-11,0	17,50
12 x 9	32	32,8	40	● 09-8032-12,0	17,50
14 x 11	32	32,8	40	● 09-8032-14,0	17,50
16 x 12	32	32,8	40	● 09-8032-16,0	17,50
18 x 14,5	32	32,8	40	● 09-8032-18,0	17,50
20 x 16	32	32,8	40	● 09-8032-20,0	17,50

### ER 40-GB mit Innenvierkant

#### ER 40-GB with internal square

d1 x □ mm	d2 mm	d3 mm	l1 mm	Art.-Nr. / Order no.	EUR
6 x 4,9	40	40,8	46	● 09-8040-6,0	19,10
7 x 5,5	40	40,8	46	● 09-8040-7,0	19,10
8 x 6,2	40	40,8	46	● 09-8040-8,0	19,10
9 x 7	40	40,8	46	● 09-8040-9,0	19,10
10 x 8	40	40,8	46	● 09-8040-10,0	19,10
11 x 9	40	40,8	46	● 09-8040-11,0	19,10
12 x 9	40	40,8	46	● 09-8040-12,0	19,10
14 x 11	40	40,8	46	● 09-8040-14,0	19,10
16 x 12	40	40,8	46	● 09-8040-16,0	19,10
18 x 14,5	40	40,8	46	● 09-8040-18,0	19,10
20 x 16	40	40,8	46	● 09-8040-20,0	19,10
22 x 18	40	40,8	46	● 09-8040-22,0	19,10

### ER 50-GB mit Innenvierkant

#### ER 50-GB with internal square

d1 x □ mm	d2 mm	d3 mm	l1 mm	Art.-Nr. / Order no.	EUR
8 x 6,2	50	51,4	60	● 09-8050-8,0	57,30
9 x 7	50	51,4	60	● 09-8050-9,0	57,30
10 x 8	50	51,4	60	● 09-8050-10,0	57,30
11 x 9	50	51,4	60	● 09-8050-11,0	57,30
12 x 9	50	51,4	60	● 09-8050-12,0	57,30
14 x 11	50	51,4	60	● 09-8050-14,0	57,30
16 x 12	50	51,4	60	● 09-8050-16,0	57,30
18 x 14,5	50	51,4	60	● 09-8050-18,0	57,30
20 x 16	50	51,4	60	● 09-8050-20,0	57,30
22 x 18	50	51,4	60	● 09-8050-22,0	57,30
25 x 20	50	51,4	60	● 09-8050-25,0	57,30
28 x 22	50	51,4	60	● 09-8050-28,0	57,30
32 x 24	50	51,4	60	● 09-8050-32,0	57,30

Abgedichtete Gewindebohrzangen auf Anfrage lieferbar  
Sealed tapping collets available upon request



# Gewindebohrzangen mit Längenausgleich

## Tapping collets with length compensation

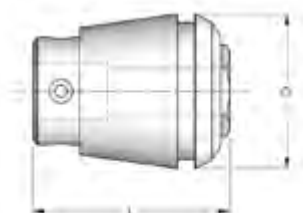

### Gewindebohrzangen ER mit Längenausgleich

#### Tapping collets ER with length compensation

SZ / Collet	Spann-Ø / Clamping-Ø mm	D mm	L mm	T mm	Art.-Nr. / Order no.	EUR
ER 16	Ø 2,5 - Ø 6,0	17	27	7	09-6016-Ø	58,90
ER 20	Ø 2,8 - Ø 7,0	21	31	7	09-6020-Ø	58,90
ER 25	Ø 2,5 - Ø 10,0	26	34	8	09-6025-Ø	66,00
ER 32	Ø 4,5 - Ø 12,0	33	43	10	09-6032-Ø	66,00
ER 40	Ø 6,0 - Ø 16,0	41	54	13	09-6040-Ø	98,60

SZ / Collet	Standard-Ø / Standard-Ø mm
ER 16	2,5 / 2,8 / 3,5 / 4,5 / 6,0
ER 20	2,8 / 3,5 / 4,5 / 6,0 / 7,0
ER 25	2,5 / 2,8 / 3,5 / 4,5 / 6,0 / 7,0 / 8,0 / 9,0 / 10,0
ER 32	4,5 / 6,0 / 7,0 / 8,0 / 9,0 / 10,0 / 11,0 / 12,0
ER 40	6,0 / 7,0 / 8,0 / 9,0 / 10,0 / 11,0 / 12,0 / 14,0 / 16,0

Andere Abmessungen lieferbar auf Anfrage  
Further dimensions available upon request

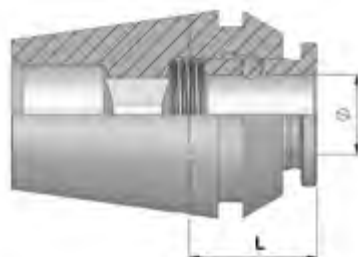

### Gewindebohrzangen ER ohne Längenausgleich, mit Schnellwechselsystem

#### Tapping collets ER without length compensation, with quick-change system

SZ / Collet	Spann-Ø / Clamping-Ø mm	D mm	L mm	Art.-Nr. / Order no.	EUR
ER 16	Ø 3,5 - Ø 6,0	17	11	09-5016-Ø	36,10
ER 20	Ø 3,5 - Ø 7,0	21	17	09-5020-Ø	36,10
ER 25	Ø 3,5 - Ø 10,0	26	18,5	09-5025-Ø	37,20
ER 32	Ø 4,5 - Ø 12,0	33	18,5	09-5032-Ø	38,50
ER 40	Ø 6,0 - Ø 16,0	41	19	09-5040-Ø	40,80

SZ / Collet	Standard-Ø / Standard-Ø mm
ER 16	3,5 / 4,5 / 6,0
ER 20	3,5 / 4,5 / 6,0 / 7,0
ER 25	3,5 / 4,5 / 6,0 / 7,0 / 8,0 / 9,0 / 10,0
ER 32	4,5 / 6,0 / 7,0 / 8,0 / 9,0 / 10,0 / 11,0 / 12,0
ER 40	6,0 / 7,0 / 8,0 / 9,0 / 10,0 / 11,0 / 12,0 / 14,0 / 16,0

Andere Abmessungen lieferbar auf Anfrage  
Further dimensions available upon request



# Spannzangen Typ Erickson Collets type Erickson



## Typ 412 E (DK-S), 0,25 mm steigend / stepped

**NEU** !

D mm	d3 mm	l1 mm	Art.-Nr. / Order no.	EUR
1-2	6,8	16,3	▶ 06-412E-Ø	23,40
2,25-3	6,8	16,3	▶ 06-412E-Ø	22,90
3,25-4	6,8	16,3	▶ 06-412E-Ø	15,60

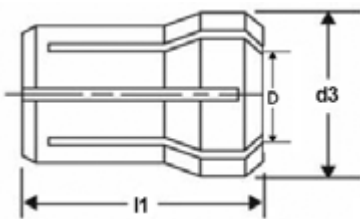

## Typ 416 E (DK30), 0,5 mm steigend / stepped

**NEU** !

D mm	d3 mm	l1 mm	Art.-Nr. / Order no.	EUR
1-2,5	9,5	25,4	▶ 06-416E-Ø	9,70
3-6,5	9,5	25,4	▶ 06-416E-Ø	8,70

## Typ 417 E (DK20), 0,5 mm steigend / stepped

**NEU** !

D mm	d3 mm	l1 mm	Art.-Nr. / Order no.	EUR
1-2,5	13,6	30,3	▶ 06-417E-Ø	10,00
3-10	13,6	30,3	▶ 06-417E-Ø	8,80

## Typ 418 E (DK10), 0,5 mm steigend / stepped

**NEU** !

D mm	d3 mm	l1 mm	Art.-Nr. / Order no.	EUR
1-2,5	19,4	36,7	▶ 06-418E-Ø	10,70
3-14,5	19,4	36,7	▶ 06-418E-Ø	9,60

## Sonstige Spannzangen, rund Collets, round

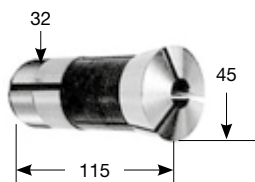
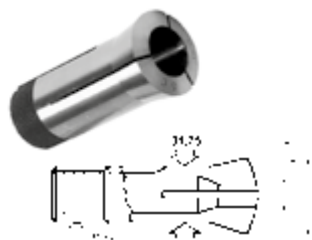

## Direktspannzangen Taper collets



### Typ 385 E (5C), 0,5 mm steigend / 0,5 mm stepped

D mm	Art.-Nr. / Order no.	EUR
1 - 2,5 mm	● 06-385E-Ø	9,90
3 - 27 mm	● 06-385E-Ø	8,50
27,5 - 30 mm	● 06-385E-Ø	11,40

### Typ 386 E, 0,5 mm steigend / 0,5 mm stepped

D mm	Art.-Nr. / Order no.	EUR
1 - 2,5 mm	● 06-386E-Ø	23,40
3 - 29 mm	● 06-386E-Ø	23,10

### Typ 369 E (R8), 1 mm steigend / 1 mm stepped

D mm	Art.-Nr. / Order no.	EUR
2 mm	● 06-369E-Ø	10,40
3 - 22 mm	● 06-369E-Ø	8,80

### Mit Morsekegel With morse taper

MK / MT	Ø mm	Innengewinde / Internal thread	Art.-Nr. / Order no.	EUR
2	2, 3, 4, 5, 6, 8, 10, 12	M10	● 06-228-2-Ø	12,20
3	3, 4, 5, 6, 8, 10, 12, 14, 16, 18	M12	● 06-228-3-Ø	14,50
4	3, 4, 5, 6, 8, 10, 12, 14, 16, 18, 20, 22, 24, 25	M16	● 06-228-4-Ø	16,10

### Typ 574 E mit Steilkegel Type 574 E with steep taper

SK	Ø mm	Gewinde / Thread	Art.-Nr. / Order no.	EUR
40	4, 5, 6, 8, 10, 12, 14, 16, 18, 20, 22, 24, 25	S20 x 2	▶ 06-DSSK-S20-Ø	66,10

### Typ 575 E mit Steilkegel Type 575 E with steep taper

SK	Ø mm	Gewinde / Thread	Art.-Nr. / Order no.	EUR
40	4, 5, 6, 8, 10, 12, 14, 16, 18, 20, 22, 24, 25	M16	▶ 06-DSSK-M16-Ø	66,10

# Spannzangen DIN 6343 Collets DIN 6343

## Typ 161 E, 0,5 mm steigend / 0,5 mm stepped

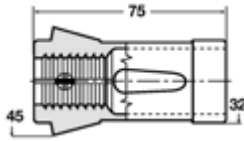

D mm	Form / form	Art.-Nr. / Order no.	EUR
3-26 mm	rund / round	06-161E-Ø	17,50

Bis Ø 7 mm - glatte Bohrung, ab Ø 8 mit Querrillen  
Up to Ø 7 mm - smooth bore, from Ø 8 mm - radial grooved

## Typ 163 E, 0,5 mm steigend / 0,5 mm stepped

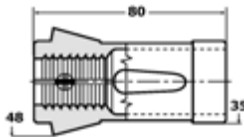

D mm	Form / form	Art.-Nr. / Order no.	EUR
2-30 mm	rund / round	06-163E-Ø	21,90
Nofallspannzange / Emergency collet 163 E		06-163E-NOT	28,70

Bis Ø 7 mm - glatte Bohrung, ab Ø 8 mit Querrillen  
Up to Ø 7 mm - smooth bore, from Ø 8 mm - radial grooved

## Typ 173 E, 0,5 mm steigend / 0,5 mm stepped

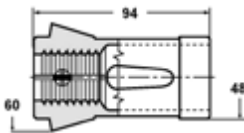

Größe / Size	Form / form	Art.-Nr. / Order no.	EUR
Ø 3 - 42 mm	rund / round	06-173E-Ø	29,20
□ 4 - 30 mm	vierkant / square	06-173E-Ø-4Kant	48,70
⬡ 4 - 36 mm	sechskant / hexagonal	06-173E-Ø-6Kant	48,70
Nofallspannzange / Emergency collet 173 E		06-173E-NOT	58,50

Bis Ø 7 mm - glatte Bohrung, ab Ø 8 mit Querrillen  
Up to Ø 7 mm - smooth bore, from Ø 8 mm - radial grooved

## Typ 185 E, 1 mm steigend / 1 mm stepped

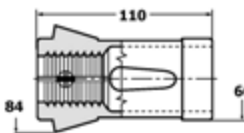

Größe / Size	Form / form	Art.-Nr. / Order no.	EUR
Ø 4 - 60 mm	rund / round	06-185E-Ø	46,80
□ 10 - 42 mm	vierkant / square	06-185E-Ø-4Kant	75,60
⬡ 6 - 52 mm	sechskant / hexagonal	06-185E-Ø-6Kant	75,60
Nofallspannzange / Emergency collet 185 E		06-185E-NOT	91,40

Bis Ø 7 mm - glatte Bohrung, ab Ø 8 mit Querrillen  
Up to Ø 7 mm - smooth bore, from Ø 8 mm - radial grooved

## Typ 193 E, 5 mm steigend / 5 mm stepped

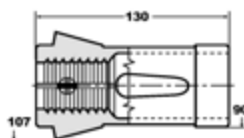

D mm	Form / form	Art.-Nr. / Order no.	EUR
20 - 80	rund / round	06-193E-Ø	189,20

Weitere Größen auf Anfrage  
Further sizes available upon request

# Spannköpfe Clamping heads



## Größe 42, rund, glatt Size 42, round, smooth

**NEU** !

Spanndurchmesser / Clamping diameter mm	Steigung / Pitch mm	Art.-Nr. / Order no.	EUR
3 - 42	0,5	<a href="#">36-42RD-Ø</a>	ab 102,90



## Größe 42, rund, quengerillt Size 42, round, radial grooves

**NEU** !

Spanndurchmesser / Clamping diameter mm	Steigung / Pitch mm	Art.-Nr. / Order no.	EUR
8 - 42	0,5	<a href="#">36-42RD-ØQ</a>	119,00



## Größe 42, rund, längs- und quengerillt Size 42, round, radial and axial grooves

**NEU** !

Spanndurchmesser / Clamping diameter mm	Steigung / Pitch mm	Art.-Nr. / Order no.	EUR
11 - 42	0,5	<a href="#">36-42RD-ØLQ</a>	102,90

## Größe 42, sechskant, glatt Size 42, hexagonal, smooth

**NEU** !

Spanndurchmesser / Clamping diameter mm	Steigung / Pitch mm	Art.-Nr. / Order no.	EUR
7 - 38	1	<a href="#">36-42SK-Ø</a>	159,70

## Größe 42, sechskant, quengerillt Size 42, hexagonal, radial grooves

**NEU** !

Spanndurchmesser / Clamping diameter mm	Steigung / Pitch mm	Art.-Nr. / Order no.	EUR
8 - 38	1	<a href="#">36-42SK-ØQ</a>	143,80

- Lagerstandard / in stock
- innerhalb weniger Tage / within a few days
- auf Anfrage / on request
- auslaufende Größe / as stock lasts

# Spannköpfe Clamping heads



## Größe 65, rund, glatt Size 65, round, smooth

NEU  
NEW !

Spanndurchmesser / Clamping diameter mm	Steigung / Pitch mm	Art.-Nr. / Order no.	EUR
4 - 65	0,5	<a href="#">36-65RD-Q</a>	130,20



## Größe 65, rund, quengerillt Size 65, round, radial grooves

NEU  
NEW !

Spanndurchmesser / Clamping diameter mm	Steigung / Pitch mm	Art.-Nr. / Order no.	EUR
8 - 65	0,5	<a href="#">36-65RD-QQ</a>	ab 130,20



## Größe 65, rund, längs- und quengerillt Size 65, round, radial and axial grooves

NEU  
NEW !

Spanndurchmesser / Clamping diameter mm	Steigung / Pitch mm	Art.-Nr. / Order no.	EUR
11 - 65	0,5	<a href="#">36-65RD-QLQ</a>	130,20

## Größe 65, sechskant, glatt Size 65, hexagonal, smooth

NEU  
NEW !

Spanndurchmesser / Clamping diameter mm	Steigung / Pitch mm	Art.-Nr. / Order no.	EUR
7 - 56	1	<a href="#">36-65SK-Q</a>	ab 170,20

## Größe 65, sechskant, quengerillt Size 65, hexagonal, radial grooves

NEU  
NEW !

Spanndurchmesser / Clamping diameter mm	Steigung / Pitch mm	Art.-Nr. / Order no.	EUR
8 - 56	1	<a href="#">36-65SK-QQ</a>	ab 170,20

## Spannzangen-Sätze, 1 mm steigend Collet sets, 1 mm stepped



### Spannzangen-Sätze ER in Holzleiste DIN 6499 Collet sets ER in wooden tray DIN 6499

Typ / Type	D mm	Anzahl d. Spannzangen / Number of collets	Art.-Nr. / Order no.	EUR
ER 11 (4008E)*	1-7	13	09-SATZ-ER11HL	72,40
ER 16 (426E)	1-10	10	09-SATZ-ER16HL	49,30
ER 20 (428E)	2-13	12	09-SATZ-ER20HL	60,80
ER 25 (430E)	2-16	15	09-SATZ-ER25HL	75,10
ER 32 (470E)	3-20	18	09-SATZ-ER32HL	93,40
ER 40 (472E)	4-26	23	09-SATZ-ER40HL	147,30

\* 0,5 mm steigend  
\* 0,5 mm stepped



### Spannzangen-Sätze ER im Aluminiumkoffer DIN 6499 Collet sets ER in aluminium case DIN 6499

Typ / Type	D mm	Anzahl d. Spannzangen / Number of collets	Art.-Nr. / Order no.	EUR
ER 16 (426E)	1-10	10	09-SATZ-ER16AK	55,60
ER 20 (428E)	2-13	12	09-SATZ-ER20AK	66,70
ER 25 (430E)	2-16	15	09-SATZ-ER25AK	80,10
ER 32 (470E)	3-20	18	09-SATZ-ER32AK	100,00
ER 40 (472E)	4-26	23	09-SATZ-ER40AK	153,40

### Präzisions-Spannzangen-Sätze ER in Holzleiste Precision collet sets ER in wooden tray

- Präzisionsausführung - precision type



Typ / Type	D mm	Anzahl d. Spannzangen / Number of collets	Art.-Nr. / Order no.	EUR
ER 11 (4008E)	1-7	7	09-SATZ-ER11-UP	54,10
ER 16 (426E)	1-10	10	09-SATZ-ER16-UP	77,40
ER 20 (428E)	2-13	12	09-SATZ-ER20-UP	93,40
ER 25 (430E)	2-16	15	09-SATZ-ER25-UP	127,30
ER 32 (470E)	3-20	18	09-SATZ-ER32-UP	146,70
ER 40 (472E)	4-26	23	09-SATZ-ER40-UP	233,30



### Spannzangen-Sätze OZ in Holzleiste DIN 6388 Collet sets OZ in wooden tray DIN 6388

Typ / Type	D mm	Anzahl d. Spannzangen / Number of collets	Art.-Nr. / Order no.	EUR
415 E	2-16	15	06-SATZ-415EHL	86,30
462 E	2-25	24	06-SATZ-462EHL	137,30
467 E	4-32	29	06-SATZ-467EHL	231,40
410 E	2-16	15	06-SATZ-410EHL	96,90
444 E	2-25	24	06-SATZ-444EHL	169,90



### Spannzangen-Sätze OZ im Aluminiumkoffer DIN 6388 Collet sets OZ in aluminium case DIN 6388

Typ / Type	D mm	Anzahl d. Spannzangen / Number of collets	Art.-Nr. / Order no.	EUR
415 E	2-16	15	06-SATZ-415EAK	85,90
462 E	2-25	24	06-SATZ-462EAK	148,50
467 E	4-32	29	06-SATZ-467EAK	245,60
410 E	2-16	15	06-SATZ-410EAK	104,90
444 E	2-25	24	06-SATZ-444EAK	177,90

- Lagerstandard / in stock
- ▶ innerhalb weniger Tage / within a few days
- auf Anfrage / on request
- ✱ auslaufende Größe / as stock lasts

## Spannzangen-Sätze Collet sets



### Sonstige Spannzangen Sätze Optional collet sets

Typ / Type	D mm	Steigung / Stepping	Holzleiste / wooden tray	Anzahl d. Spannzangen / Number of collets	Art.-Nr. / Order no.	EUR
385 E	3-26	1	Ja / Yes	24	06-SATZ-385EHL	180,50
385 E	1-29	0,5	Nein / No	57	06-SATZ-385/0,5	392,80
386 E	3-29	1	Nein / No	24	06-SATZ-386E	567,00
173 E	3-42	1	Nein / No	40	06-SATZ-173E	1.060,50
173 E	3-42	0,5	Nein / No	79	06-SATZ-173E/0,5	2.116,60

## Anschlagschrauben Stop screws



### Für 5C-Spannzangen For 5C-collets

- Gewinde auf ganzer Länge gehärtet
- für einstellbare Werkstücktiefen bis 75 mm (von Spannzangenoberfläche)
- *thread hardened over entire length*
- *for adjustable work piece depths up to 75 mm (from collet surface)*

D mm	Art.-Nr. / Order no.	EUR
für 5C-Spannzangen / for 5C-collets	06-106220	8,20

### Für Spannzangen DIN 6343 For collets DIN 6343

- für Spannzangen 163E, 173E, 185E
- *for collets 163E, 173E, 185E*

D mm	Art.-Nr. / Order no.	EUR
für 173E / for 173E	06-173E-AN	65,70
für 185E / for 185E	06-185E-AN	98,00





## Aluminiumkoffer Aluminium cases



### Für Spannzangen For collets

Passend für / Suitable for	Anzahl der Plätze / Number of seats	Art.-Nr. / Order no.	EUR
ER 16	10	● 09-ER16-AK	13,20
ER 20	13	● 09-ER20-AK	13,20
ER 25 / 415E / 410E	16	● 09-ER25/415E-AK	15,20
ER 32	20	● 09-ER32-AK	15,20
462E / 444E	25	● 09-462E-AK	15,20
ER 40 / 467E / 450E	30	● 09-ER40/467E-AK	25,10



### Für Spannzangen und Futter For collets and collet chucks

- geeignet für Spannzangensatz und Spannzangenfutter SK30 und SK40
- suitable for collet set and collet chucks SK30 and SK40

Passend für / Suitable for	Anzahl der Plätze / Number of seats	Art.-Nr. / Order no.	EUR
ER 25	16	● 09-ALK-ER25	21,60
ER 32	20	● 09-ALK-ER32	21,60
ER 40	24	● 09-ALK-ER40	21,60



### Für Kantentaster For edge finders

Passend für / Suitable for	Abmessungen / Dimensions mm	Art.-Nr. / Order no.	EUR
0I-129055-N	140 x 56 x 42	● 42-1010-AK	8,20

**Kantentaster siehe Seite 271**  
**Edge finders see page 271**